

PENINSULA POINTE

by COGIR



PENINSULA POINTE BY COGIR: THE REWARDS OF A LIFE WELL LIVED

PENINSULA POINTE BY COGIR

Peninsula Pointe by Cogir is an Assisted Living and Memory Care community in Rolling Hills Estates. We create an engaging and joyful lifestyle for our residents with impeccable attention to care and comfort. Experience the coastal breezes from the outdoor courtyard and have your daily needs handled by our expert staff. All of the amenities you want and engaging activities await to give you the ideal senior living experience. Make new connections, discover new passions and live the life you want.

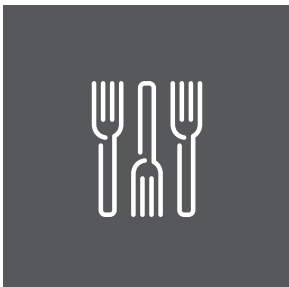



PENINSULA POINTE BY COGIR: THE REWARDS OF A LIFE WELL LIVED

As with all COGIR communities, delicious high-quality meals are served throughout the day and attentive staff are ready with a smile for any need. Peninsula Pointe by Cogir is ideally located in Rolling Hills Estates with nearby sights such as the South Coast Botanical Gardens, Abolen Cove State Beach and Point Vincent Lighthouse. With the Peninsula Center across the street and many popular dining options, there's always something to see and do.

WHY CHOOSE PENINSULA POINTE BY COGIR:

- All-day restaurant-style dining
- Chef-prepared menu
- Transportation for outings and medical visits
- Daily events and activities for fun and learning
- Fitness and therapy centers
- Hair and beauty salon
- Carport and surface parking
- Game room with billiards
- Library
- Courtyard and walking paths
- Theater
- Art Room
- Lobby
- Memory care common area
- Complete WIFI coverage in common areas
- On-site nursing
- Emergency Response System throughout property
- Pet Friendly

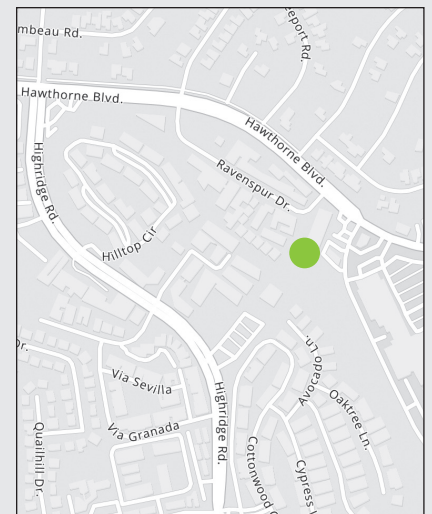

PENINSULA POINTE BY COGIR
 27520 Hawthorne Boulevard
 Rolling Hills Estates, CA 90274

(310) 697-6236



Rev. 05/23

OUR COMMUNITY OFFERS SPACIOUS STUDIO AND ONE BEDROOM APARTMENT-HOMES

PENINSULA POINTE BY COGIR: THE REWARDS OF A LIFE WELL LIVED



FOR ASSISTED LIVING

If you or a loved one requires attentive daily assistance, the large team of passionate professional caregivers at the Peninsula Pointe by Cogir is eager to welcome you to our family and share the high-quality services, meals, and activities that define the Cogir brand.

Assisted living residents will enjoy hotel-like amenities with the added personalized attention and care in the privacy and security of their apartment home. Prior to moving into their new home, each assisted resident and their family will meet with our care team to develop a tailored care plan based on the resident's needs, personality, and wishes.

FOR MEMORY CARE

Peninsula Pointe's RevereSM Memory Care program offers a personalized approach that emphasizes personal connections through familiar activities and events. Experience peace of mind knowing that your loved one is in a safe and supportive environment.

Our skilled team focuses on engaging activities and comprehensive care. We create personalized care plans designed specifically for those facing Alzheimer's or Dementia.



PERSONALIZED CARE PLANS CAN INCLUDE ASSISTANCE WITH

- Daily tasks (hygiene, dressing, etc.)
- Mobility
- Dining
- Contenance Care
- Medication management
- Diabetes assistance



PENINSULA POINTE BY COGIR

27520 Hawthorne Boulevard, Rolling Hills Estates, CA 90274 • (310) 697-6236

License # PENDING

STUDIO
410 SQ. FT.*

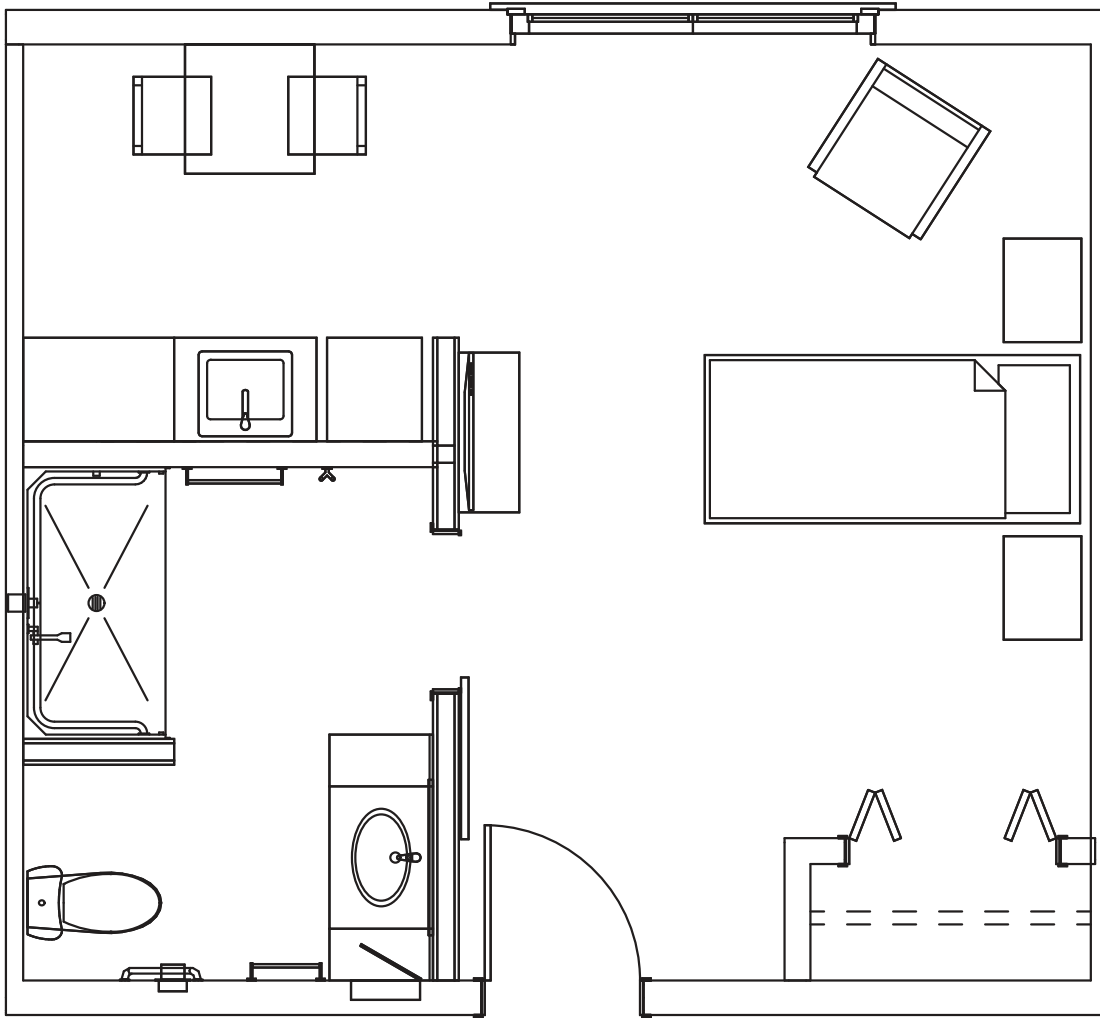



*All square footage figures are approximate. Residence size and layout may vary from illustrations.

PENINSULA POINTE BY COGIR

27520 Hawthorne Boulevard, Rolling Hills Estates, CA 90274 • (310) 697-6236

License # PENDING

STUDIO
415 SQ. FT.*

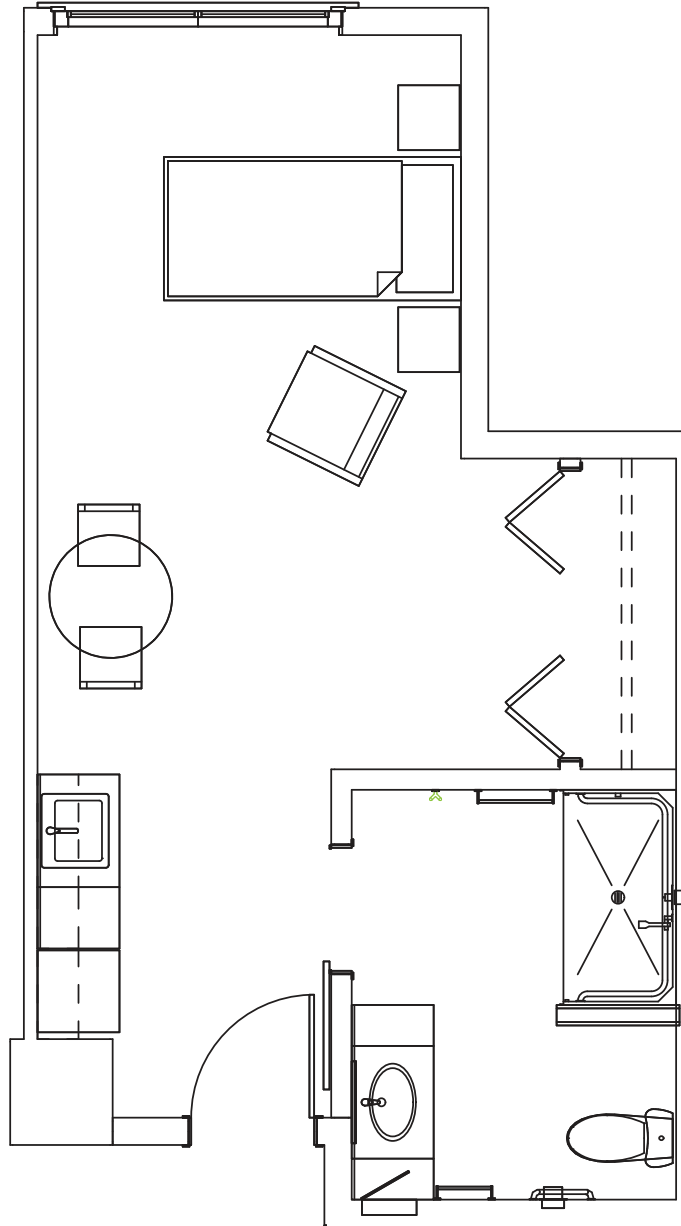



*All square footage figures are approximate. Residence size and layout may vary from illustrations.

PENINSULA POINTE BY COGIR

27520 Hawthorne Boulevard, Rolling Hills Estates, CA 90274 • (310) 697-6236
License # PENDING

STUDIO
420 SQ. FT.*

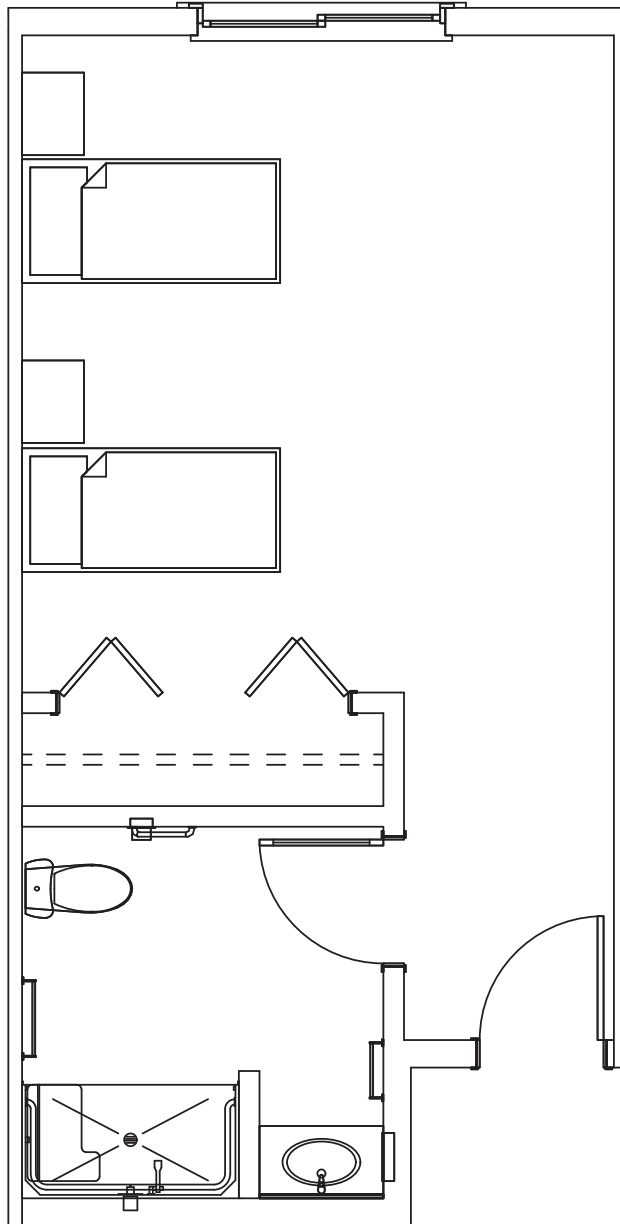



*All square footage figures are approximate. Residence size and layout may vary from illustrations.

PENINSULA POINTE BY COGIR

27520 Hawthorne Boulevard, Rolling Hills Estates, CA 90274 • (310) 697-6236

License # PENDING

STUDIO
431 SQ. FT.*

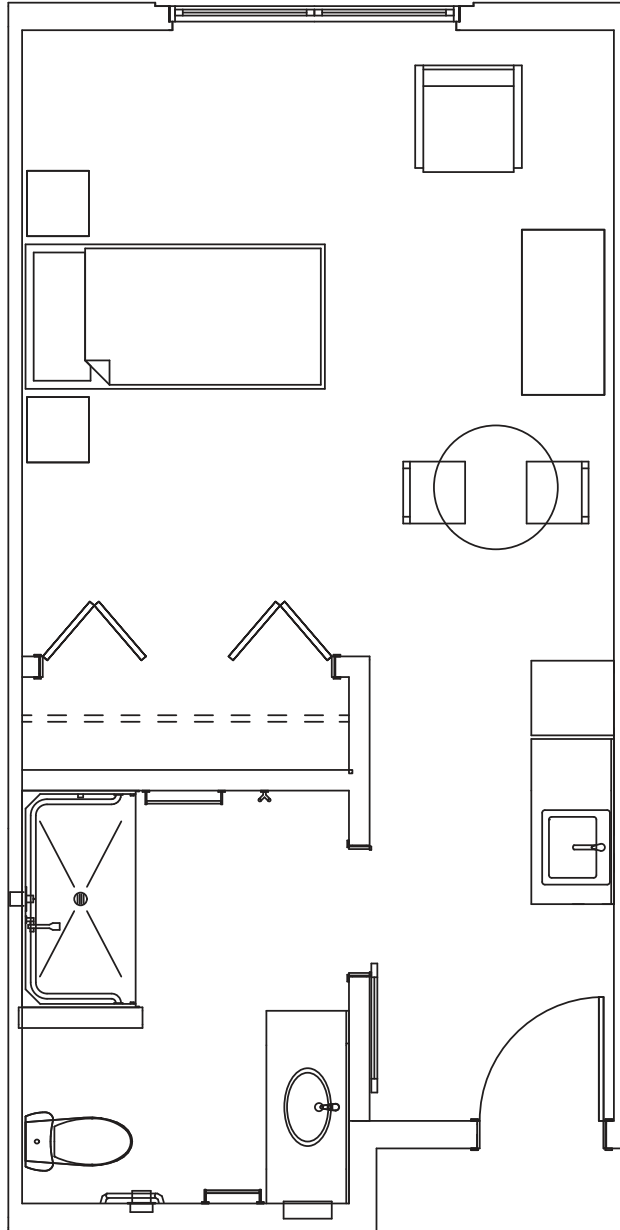



*All square footage figures are approximate. Residence size and layout may vary from illustrations.

PENINSULA POINTE BY COGIR

27520 Hawthorne Boulevard, Rolling Hills Estates, CA 90274 • (310) 697-6236

License # PENDING

STUDIO
443 SQ. FT.*

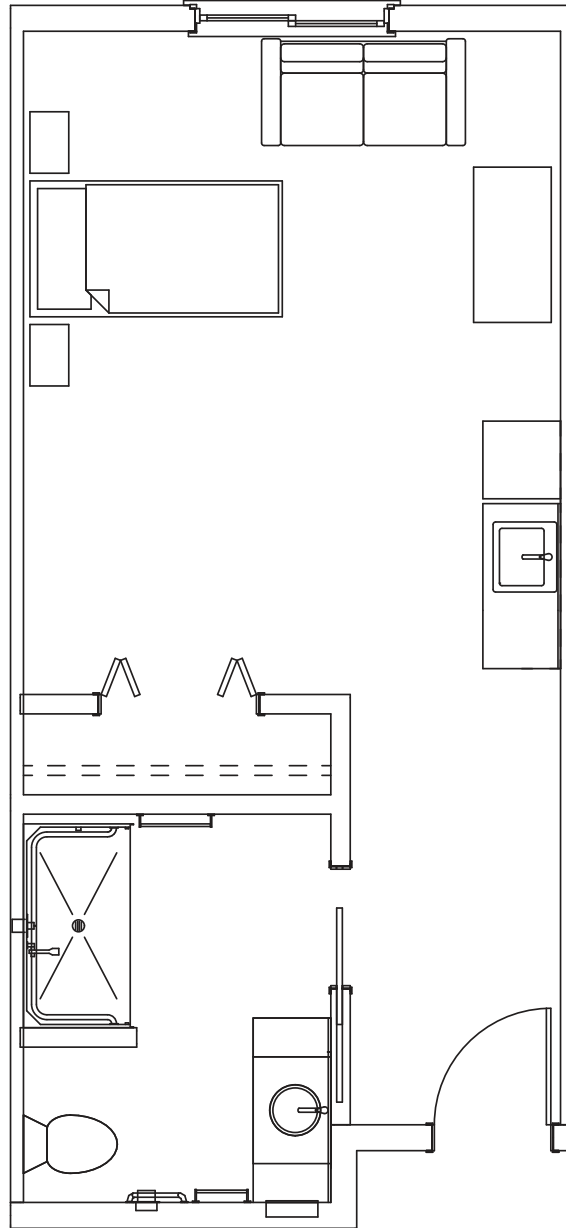



*All square footage figures are approximate. Residence size and layout may vary from illustrations.

PENINSULA POINTE BY COGIR

27520 Hawthorne Boulevard, Rolling Hills Estates, CA 90274 • (310) 697-6236

License # PENDING

STUDIO
478 SQ. FT.*

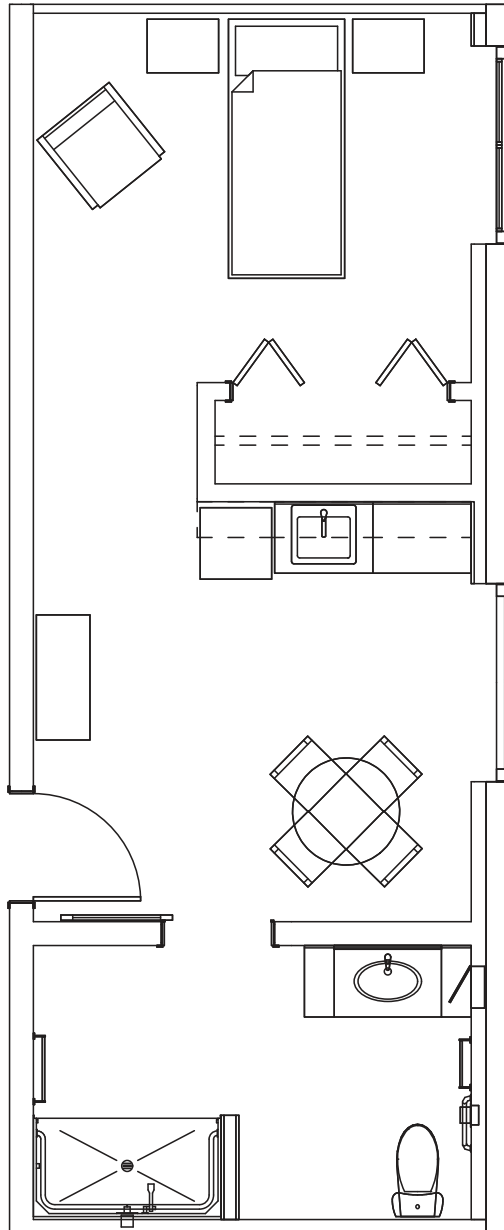



*All square footage figures are approximate. Residence size and layout may vary from illustrations.

PENINSULA POINTE BY COGIR

27520 Hawthorne Boulevard, Rolling Hills Estates, CA 90274 • (310) 697-6236
License # PENDING

STUDIO
532 SQ. FT.*

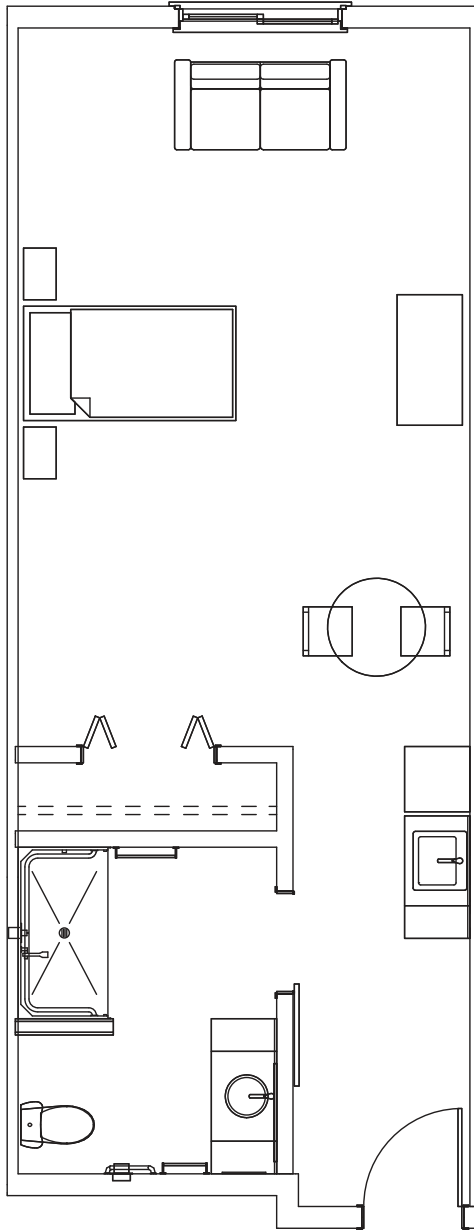



*All square footage figures are approximate. Residence size and layout may vary from illustrations.

PENINSULA POINTE BY COGIR

27520 Hawthorne Boulevard, Rolling Hills Estates, CA 90274 • (310) 697-6236

License # PENDING

DELUXE STUDIO

512 SQ. FT.*

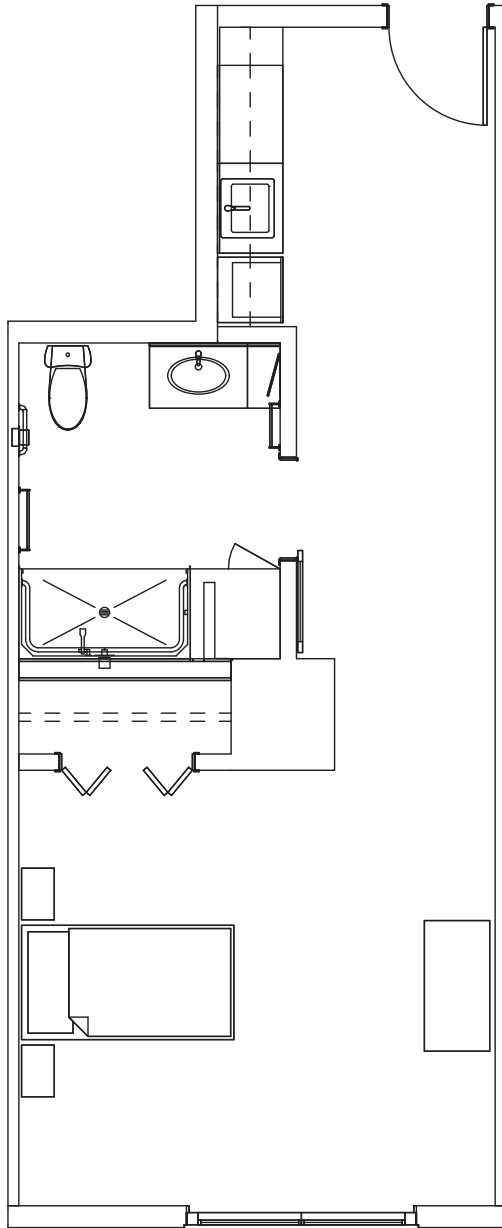



*All square footage figures are approximate. Residence size and layout may vary from illustrations.

PENINSULA POINTE BY COGIR

27520 Hawthorne Boulevard, Rolling Hills Estates, CA 90274 • (310) 697-6236

License # PENDING

DELUXE STUDIO

558 SQ. FT.*

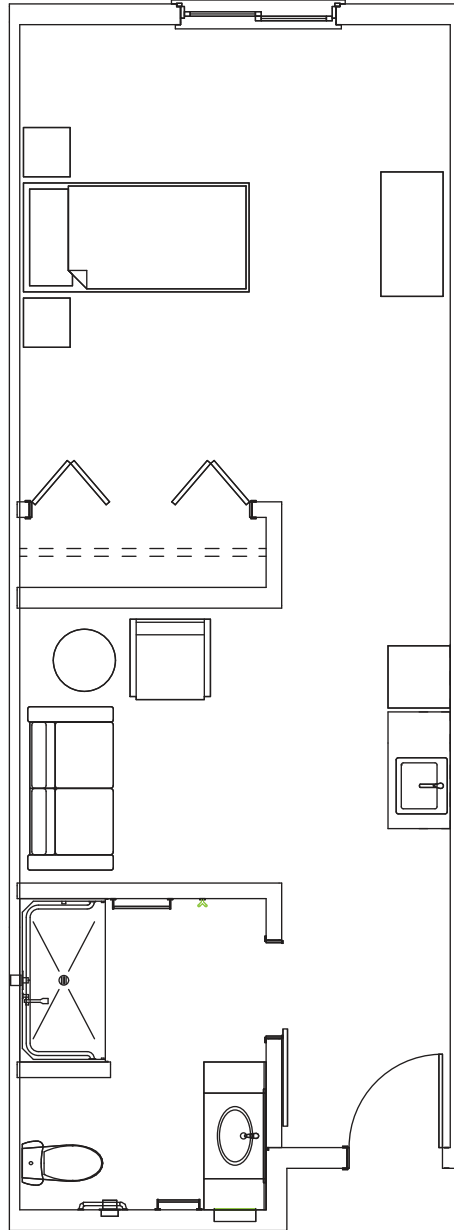



*All square footage figures are approximate. Residence size and layout may vary from illustrations.

PENINSULA POINTE BY COGIR

27520 Hawthorne Boulevard, Rolling Hills Estates, CA 90274 • (310) 697-6236

License # PENDING

DELUXE STUDIO

541 SQ. FT.*

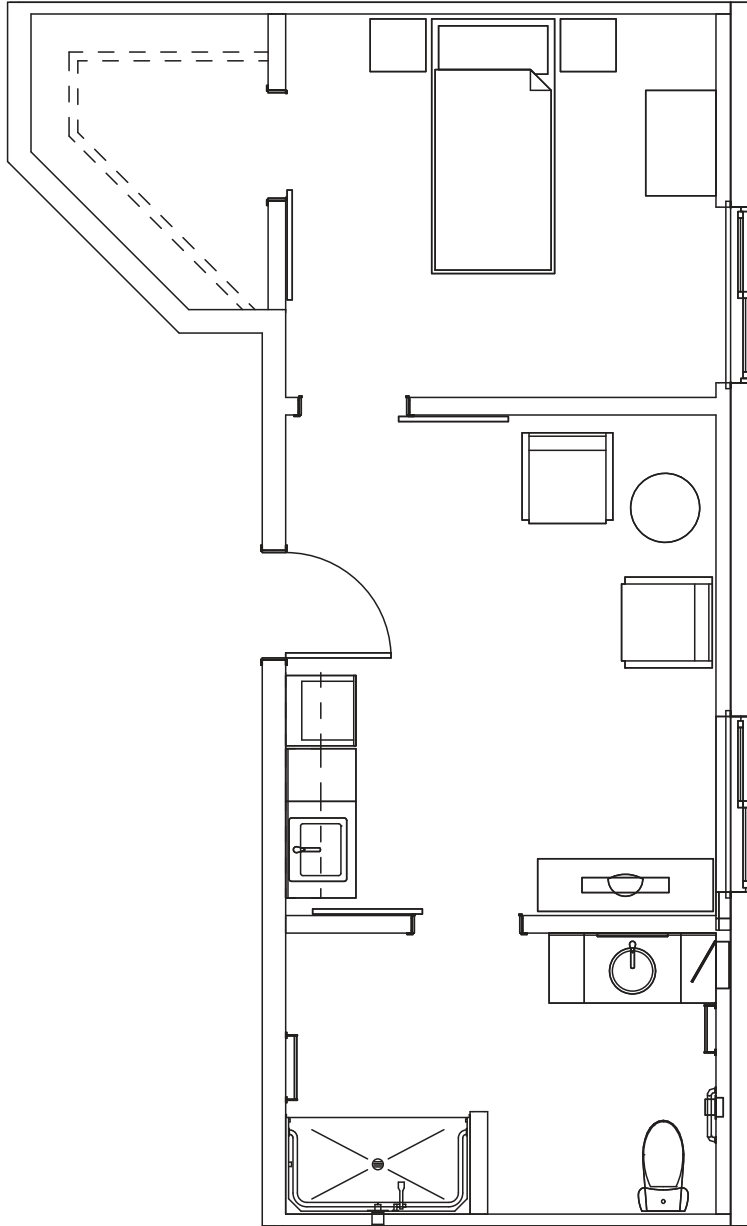

*All square footage figures are approximate. Residence size and layout may vary from illustrations.

PENINSULA POINTE BY COGIR

27520 Hawthorne Boulevard, Rolling Hills Estates, CA 90274 • (310) 697-6236

License # PENDING

1 BEDROOM

657 SQ. FT.*

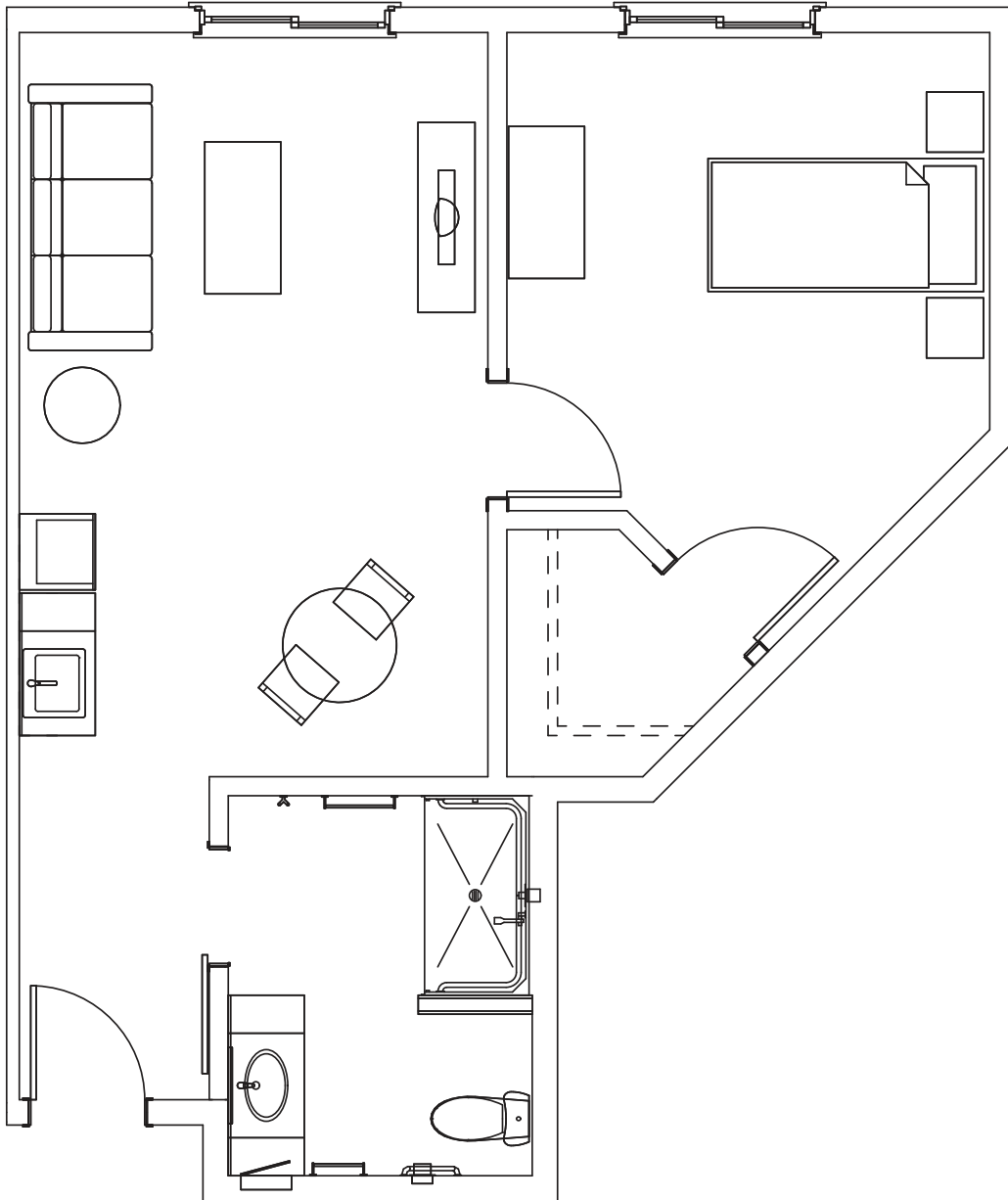



*All square footage figures are approximate. Residence size and layout may vary from illustrations.

PENINSULA POINTE BY COGIR

27520 Hawthorne Boulevard, Rolling Hills Estates, CA 90274 • (310) 697-6236
License # PENDING

MC STUDIO
423 SQ. FT.*

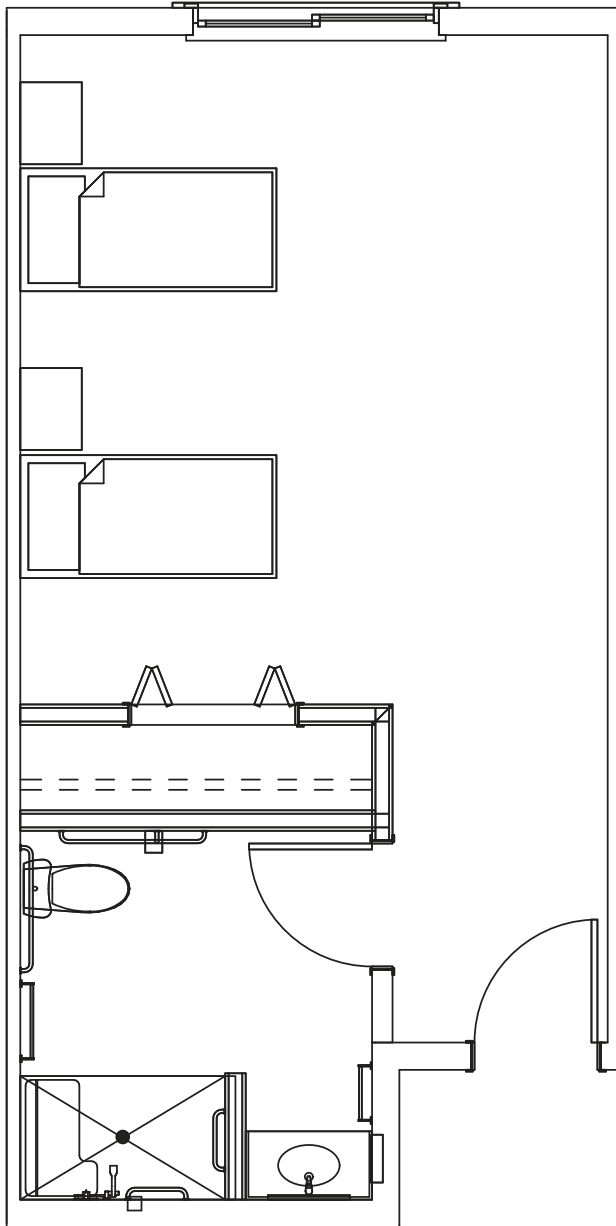



*All square footage figures are approximate. Residence size and layout may vary from illustrations.

PENINSULA POINTE BY COGIR

27520 Hawthorne Boulevard, Rolling Hills Estates, CA 90274 • (310) 697-6236

License # PENDING

MC STUDIO

490 SQ. FT.*

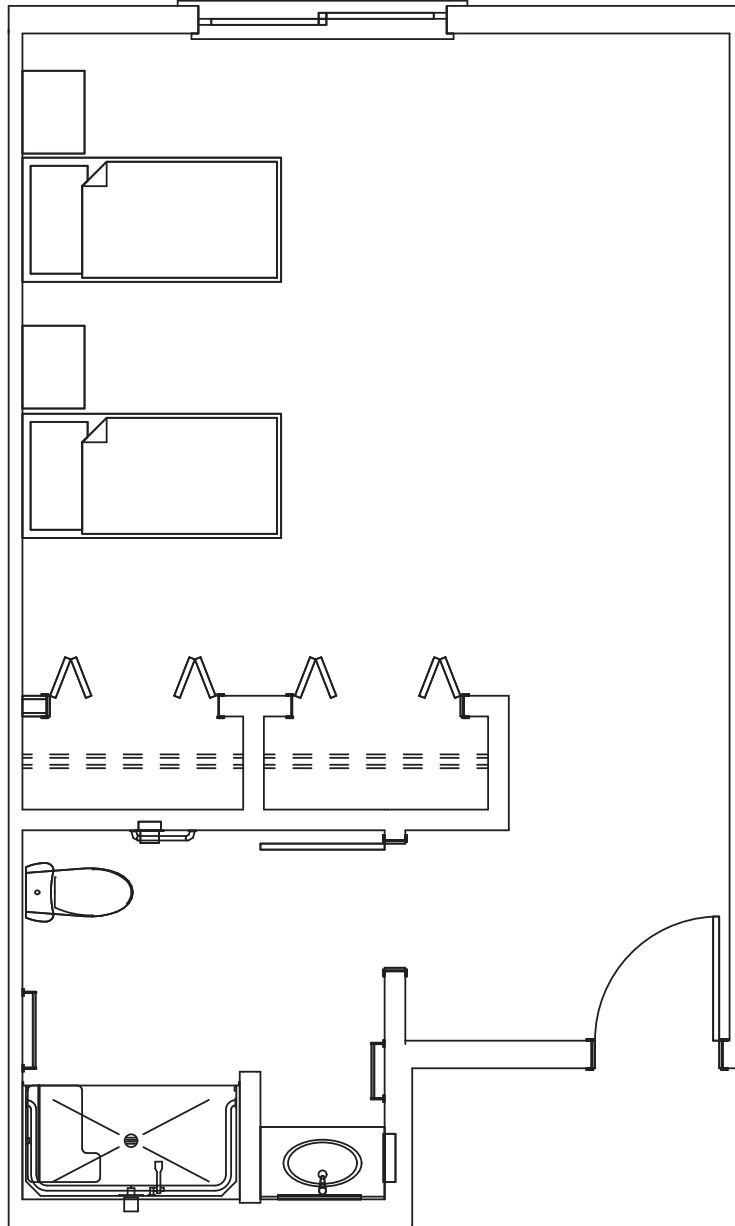



*All square footage figures are approximate. Residence size and layout may vary from illustrations.